





**TEMPORIZZATORI
CONTAIMPULSI
CONTAORE
PROGRAMMATORI ORARI**

Temporizzatori, Contaimpulsivi, Contaore, Programmatori orari - Tabella di selezione

Temporizzatori			Multifunzione	Ritardato all'eccitazione	Ritardato alla diseccitazione	Pausa/Lavoro	Ciclico	Uscita ad impulso	Stella-triangolo	Montaggio su pannello	Montaggio su zoccolo	Montaggio circuito stampato	Guida DIN	Formato								
Serie	Pag.																					
Analogico	S1DX			•			•	•		•	•	•		miniatura 22x28 mm								
	PM5S		•	•	•		•	•					•	guida DIN 22,5 mm								
	PM4H		•	•	•	•	•	•	•	•	•			DIN48								
Digitale	LT4H*		•	•	•		•	•		•	•			DIN48								
	LT4HW*		•			•				•	•			DIN48								
	QM4H			•						•				DIN48								
Contaimpulsivi			Ingresso			Pre selezione		Velocità di conteggio		Reset	Uscita			Alimentazione			Terminali		Cifre display			
Serie	Pag.	contatto o multirivisione	a contatto e a transistor	a transistor PNP	singola	doppia	30Hz/2KHz	30Hz/5KHz	frontale e remoto	1 in scambio o NPN/PNP selezionabili	2 contatti NO o NPN/PNP selezionabili	autoalimentato	da 100 a 240 VAC	24V AC/DC da 12 a 14	24V AC/DC 12/24 VDC 100-240 VAC	PIN	a vite	8	4/6	6		
Digitale	LC2H*		•				•		•			•				•	•	•				
	LC4H*			•		•		•	•	•			•			•	•		•			
	LC4H-SV*			•	•	•		•	•	•				•		•	•		•			
	LC4HW*			•		•		•	•		•		•			•	•				•	
Contaore			Scale dei tempi						Reset	Assorbimento ca 1,5W	Alimentazione				Conteggio in addizione							
Serie	Pag.	da 0 a 9999,9m	da 0 a 9999,9h	da 0 a 99999,9h	da 0 a 999999,9h	parziale da 0 a 9999,9h totalizzatore da 0 a 99999,9h	12VDC 24VDC	12VDC 24VDC 24VAC, 48VAC, da 115 a 120 VAC, 220VAC			da 115 a 120VAC	autoalimentato										
Digitale	LH2H*				•			•	•		•		•		•							
Analogico	TH13/23			•	•				•	•		•									•	
	TH8				•					•		•										•
	TH14/24			•	•					•	•		•									•
	TH40							•		•	•		•									•
	TH50		•							•	•		•									•
	TH63/64			•	•					•	•		•									•
Programmatori orari			giornaliero	settimanale	1 relé in scambio	2 relé in scambio	elettronico	con motore al quarzo	consumo 2W	protezioneIP20	settaggio con cavalieri	riserva di carica	attacco barra DIN	classe II di protezione								
Serie	Pag.																					
Analogico	TB6			•	•			•	•		•	•	•	•								
Digitale	TB5		•	•	•			•	•		•	•	•	•								

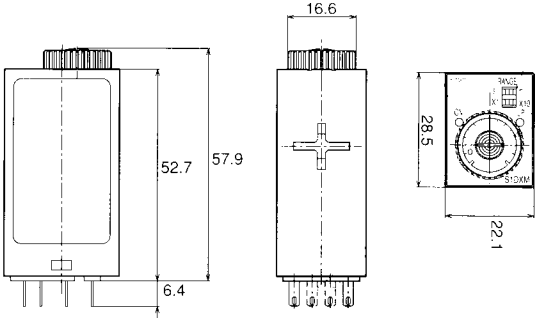
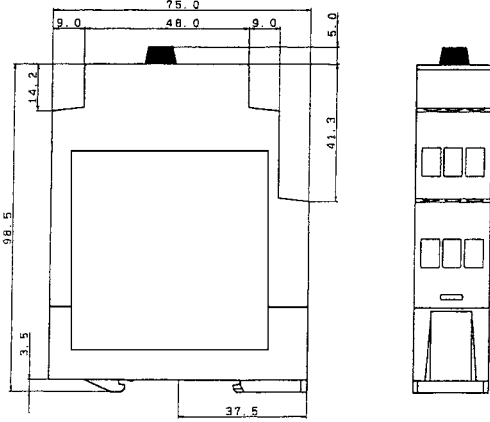
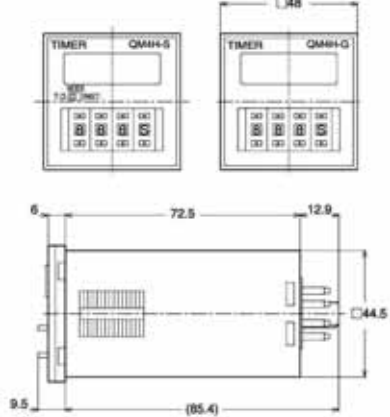
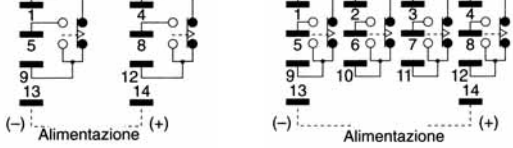
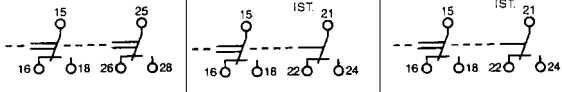
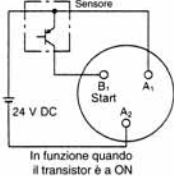

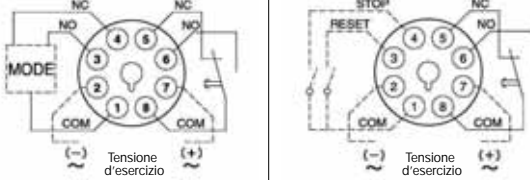
<p>Temporizzatori</p>	<p>S1DXM</p>	<p>PM5S</p>			<p>QM4H</p>		
<p>TIPOLOGIA</p>							
<p>DIMENSIONI</p>							
<p>MODELLI</p>	<p>S1DXM-A</p>	<p>S1DXM-M</p>	<p>PM5SA24240VJ</p>	<p>PM5SS24240VJ</p>	<p>PM5SM24240VJ</p>	<p>QM4H-S</p>	<p>QM4H-G</p>
<p>SCHEMI DI CABLAGGIO</p>	<p>2 contatti in scambio 4 contatti in scambio</p> 		 <p>Ingresso in tensione Collegamento di un sensore con uscita PNP</p>  <p>In funzione quando il transistor è a ON</p> <p>Ingresso a contatto</p>  <p>In funzione quando il relè è a ON</p>				

MODO DI FUNZIONAMENTO	ritardato all'eccitazione	ciclico al segnale ON ciclico al segnale OFF uscita ad impulso	ritardato all'eccitazione ciclica ON-shot ritardato segnale ON ritardato segnale OFF uscita ad impulso ON 1 ciclo	ritardo all'eccitazione	ritardato all'eccitazione ciclica ON-shot ritardato segnale ON ritardato segnale OFF uscita ad impulso ON 1 ciclo	ritardato all'eccitazione	ritardato all'eccitazione con terminali di reset e stop
TENSIONE DI ALIMENTAZIONE (V)	24VAC; 120VAC; 220VAC; 240VAC; 12VDC; 24VDC; 48VDC; 100VDC		da 24 a 240V AC/DC		da 12 a 48V AC/DC, 100 a 240V AC/DC		
SCALA DEI TEMPI	4 scale da 0,05s a 10h		da 01s a 500h, 16 scale selezionabili		8 scale da 01s a 10h		
DISPOSIZIONE DEI CONTATTI	2 in scambio; 4 in scambio		2 contatti in scambio;		1 in scambio e 1 istantaneo	2 in scambio; 1scambio + 1 istantaneo	1 in scambio
GRADO DI PROTEZIONE	IP40		IP40		IP40		
PORTATA DEI CONTATTI	2 contatti 7 A a 250VAC; 4 contatti 5A a 250VAC		5 A a 250VAC (carico resistivo)		3 A a 250VAC (carico resistivo)		
VITA MECCANICA CONTATTI	1x10 ⁸ operazioni		2x10 ⁷ operazioni		1x10 ⁷ operazioni		
VITA ELETTRICA CONTATTI	1x10 ⁸ operazioni		1x10 ⁸ operazioni		1x10 ⁸ operazioni		

Tabella codici TEMPORIZZATORI

<p>Come ordinare</p>	<p>S1DXM <input type="text"/> <input type="text"/> <input type="text"/> <input type="text"/></p> <p>A: standard M: multi scala</p> <p>Contatti in uscita 2C 4C</p> <p>Scala dei tempi 10M: 10 minuti 10H: 10 ore 30M: 30 minuti 60M: 60 minuti</p> <p>Tensione AC24V: 24VAC DC24V: 24VDC AC240V: da 220 a 240VAC</p>		<p>QM4HSU2C <input type="text"/></p> <p>Tensione 240VJ: da 100 a 240VAC/DC 48VJ: da 12 a 48VAC/DC</p> <p>QM4HGU1C <input type="text"/></p> <p>Tensione 240VJ: da 100 a 240VAC/DC 48VJ: da 12 a 48VAC/DC</p>
----------------------	--	--	---

Temporizzatori

PM4H

PM4H/SD/F/W

LT4H/LT4H-W

TIPOLOGIA



DIMENSIONI

Modello con terminale a vite (Montaggio da pannello)

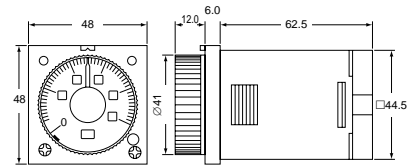

Modello con terminale a Pin (Montaggio superficiale)

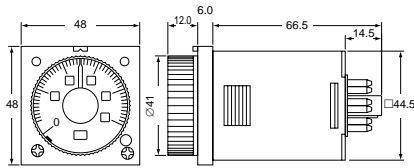

Modello con terminale a vite (Montaggio da pannello)

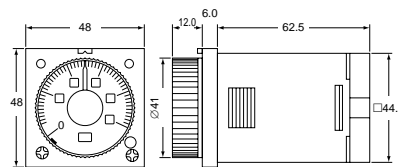

Modello con terminale a Pin (Montaggio superficiale)

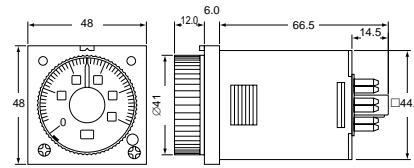

Modello con terminale a vite

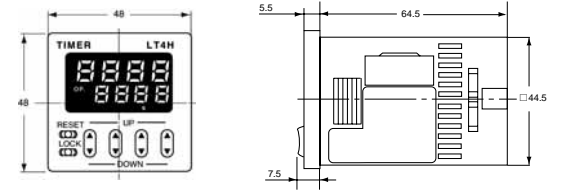

Modello con terminale a pin

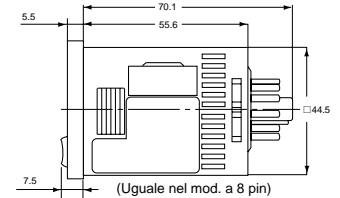

MODELLI

PM4H-A

PM4H-S

PM4H-M

PM4H-SD/SDM

PM4H-F/F8R

PM4H-W

LT4H

LT4H-W

SCHEMI DI CABLAGGIO

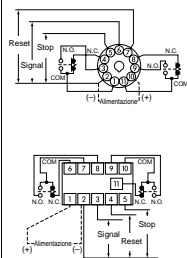

Nota: collegabile come ingresso anche transistor NPN

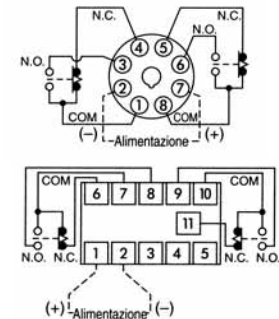

Nota: collegabile come ingresso anche transistor NPN

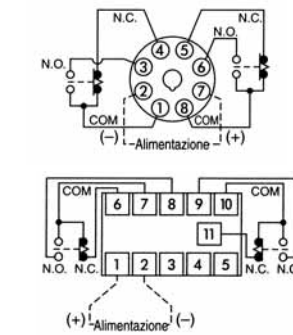
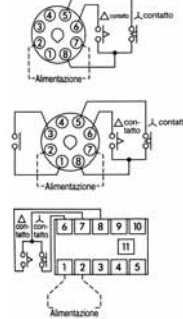

Nota: collegabile come ingresso anche transistor NPN

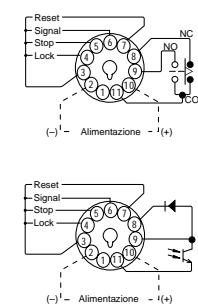

Nota: Collegabile come ingresso anche transistor NPN

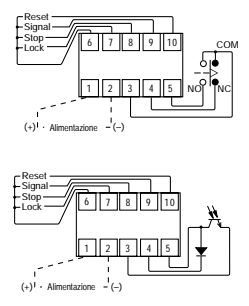

MODO DI FUNZIONAMENTO	ritardo all'eccitazione 1 ciclo Ciclica differenziata ritardato ON 1 ciclo uscita ad impulso	ritardo all'eccitazione	ritardo all'eccitazione 1 ciclo ciclica ON 1 ciclo uscita ad impulso	stella triangolo	avviamento stella triangolo ritardo alla diseccitazione	ciclico pausa lavoro	ritardo all'eccitazione 1 ritardo all'eccitazione2 ritardo al segnale ON ritardo al segnale OFF ON 1 ciclo ON ritardata ciclico totalizzatore ON ritardato	1 ciclo start OFF ciclica start OFF ciclica start ON
TENSIONE DI ALIMENTAZIONE (V)	da 100 a 240VAC, 24 AC/DC, 12VDC			da 100 a 240VAC 24VAC	da 100 a 120VAC, da 200 A240VAC, 24VAC, 12VDC, 24VDC	da 100 a 120VAC, 24VAC/DC	12-24VDC, 24VAC/DC; 100-240VAC	
SCALA DEI TEMPI	da 1s a 500h 16 scale selezionabili			4 scale da 2s a 100s	3 scale da 1s a 10s e da 1min. a 10 min.	16 scale da 0,1s a 500h	da 0,001s a 999,9h	da 0,01s a 9999h
DISPOSIZIONE DEI CONTATTI	2 contatti in scambio 1 scambio e 1 istantaneo			1NO 1NO 1NO ist (SDM)	2 in scambio 1 in scambio (F8R)	2 in scambio	1 temporizzato in scambio 1 transistor versione T	
GRADO DI PROTEZIONE	IP50/IP65			IP50/IP65			IP50/IP65	
PORTATA DEI CONTATTI	5 A a 250 VAC (carico resistivo)			5A a 250VAC (carico resistivo)	3A a 250VAC (carico resistivo)	5A a 250VAC (carico resistivo)	5A a 250VAC; 100ma A 30VDC	
VITA MECCANICA	2x10 ⁷ operazioni			2x10 ⁷ operazioni			2x10 ⁷ operazioni	
VITA ELETTRICA CONTATTI	1x10 ⁵ operazioni			2x10 ⁷ operazioni			2x10 ⁷ operazioni	

Tabella codici TEMPORIZZATORI

Come ordinare	<p>PM4H [] H [] [] [] J</p> <p>A: 8 funzioni S: ritardo all'eccitazione M: 5 funzioni</p> <p>TENSIONE AC240: da 100a 240Vac 24V: 24Vac/Vdc DC12V: 12Vdc</p> <p>_: terminali 11PIN (solo versione A) _: terminali 8PIN S: terminali a vite</p> <p>_: IP50 W: IP65</p>	<p>PM4H [] [] [] [] J</p> <p>SD: λ/D SDM: λ/D (contatto Istantaneo) F8: ritardato alla diseccitazione (senza reset) F8R: ritardato alla diseccitazione (con reset) W: multiscala e multitemperatura</p> <p>S: secondi (SD/SDM-F8/F8R) M: minuti (F8/F8R) H: ore (W)</p> <p>AC240V: da 100a 240Vac AC24V: 24Vac AV120V: da 100a 120Vac DC12V: 12Vdc</p> <p>_: terminali 8PIN S: terminali a vite (SD/SDM-W)</p> <p>_: IP50 W: IP65</p>	<p>LT4H [] [] J</p> <p>Tensione AC240V: da 100a AC240Vac AC24V: 24Vac DC24V: 24Vdc</p> <p>_: terminali 11PIN S: terminali a vite</p>
			<p>LT4HW [] [] J</p> <p>Tensione AC240V: da 100a 240Vac DC24V: 24Vac DC24V: 24Vdc</p> <p>_: terminali 11PIN S: terminali a vite</p>

Contaimpulsì

LC2H

LC4H

LC4H-W

TIPOLOGIA



DIMENSIONI

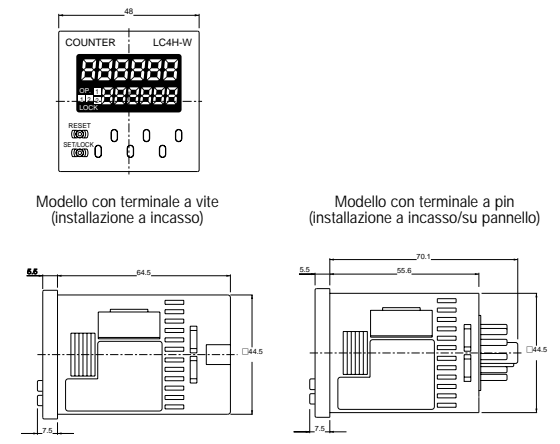
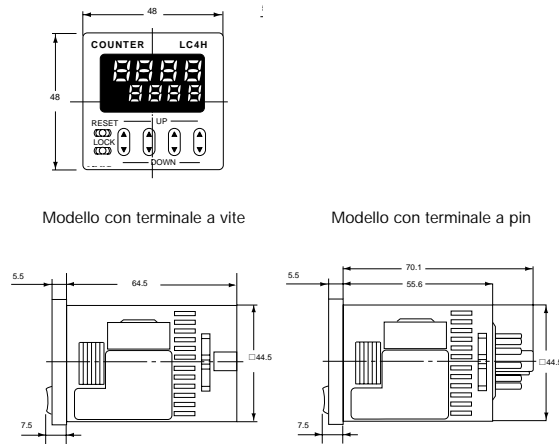
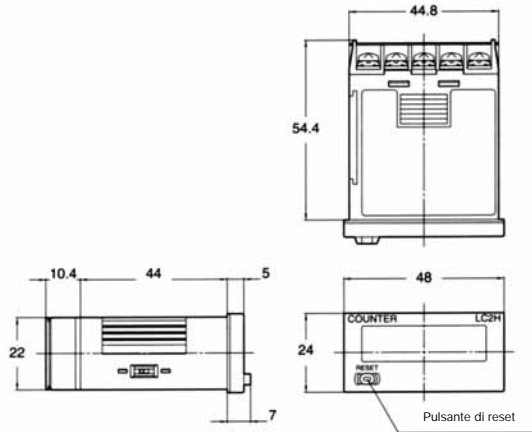

MODELLI

LC2H-F/LC2H-C/LC2H-F

LC2H-F-DL

LC2H-F-FV

LC4H

LC4H-SV/PSV

LC4H-W

SCHEMI DI CABLAGGIO

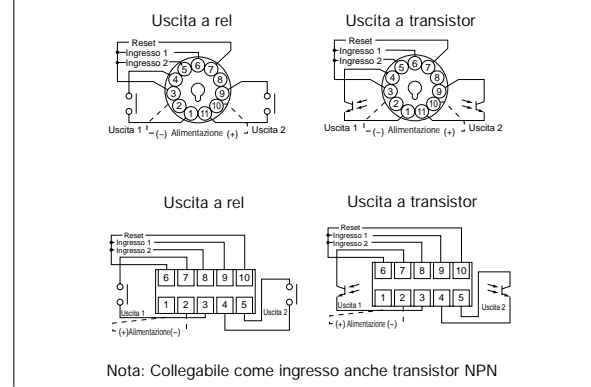
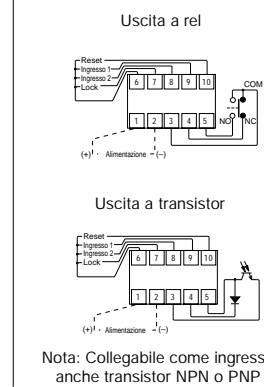
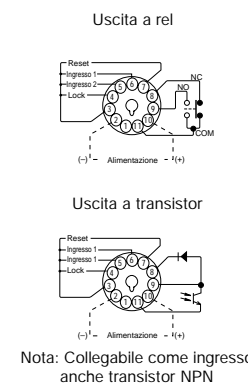
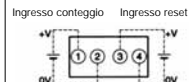
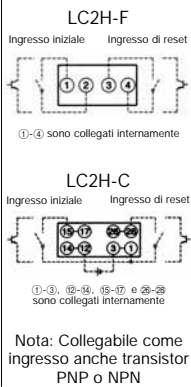

INGRESSO	ingresso non in tensione	ingresso in tensione da 4,5 a 30 VDC	ingresso in tensione da 24 a 240 VAC/DC	5 modi di ingresso: addizione, fase, sottrazione, direzionale, individuale ingresso non in tensione	5 modi di ingresso: addizione, fase, sottrazione, direzionale, indipendente ingresso in tensione, fattore di scala	5 modi di ingresso: addizione, fase, sottrazione, direzionale, indipendente
USCITA	solo totalizzatore			7 Modi di uscita: mantenuta HOLD A/B/C ad impulso SHOT A/B/C/D		4 modi uscita 1: HOLD B/C/D - SHOT A 8 modi uscita 2: HOLD A/B/C/D - SHOT A/B/C/D
ALIMENTAZIONE	batteria al litio, vita ca. 6 anni			da 100 a 240 VAC, 24V AC/DC, da 12 a 24VDC	da 100 a 240 VAC con alim. 12VDC, 24V AC/DC, 12VDC	12-24VDC, 24V AC/DC; 100 - 240 VAC
DISPLAY	8 cifre			4/6 cifre retroilluminato con doppia visualizzazione		6 cifre retroilluminato con doppia visualizzazione
DISPOSIZIONE DEI CONTATTI	-			1 contatto in scambio, 1 transistor		2 contatti in scambio, 2 transistor
GRADO DI PROTEZIONE	IP66 superficie pannello			IP66 superficie pannello		IP66 superficie pannello
PORTATA DEI CONTATTI	-			5 A a 250 VAC; 100 ma a 30VDC		3 A a 250 VAC
VITA MECCANICA CONTATTI	-			2x10 ⁷ operazioni		2x10 ⁷ operazioni
VITA ELETTRICA CONTATTI	-			1x10 ⁵ operazioni		1x10 ⁵ operazioni rel ; 1x10 ⁷ operazioni Transistor

Tabella codici CONTAIMPULSI

Come ordinare	<p>Tipo standard retro illuminato:</p> <p>LC2H <input type="text"/> J</p> <p>2KK: Ingresso non in tensione DL2KK: Ingresso in tensione FV30: Ingresso multitemperatura DL2KKB: Ingresso in tensione retroilluminato</p> <p>Tipo per montaggio su circuito stampato:</p> <p>LC2H <input type="text"/> J</p> <p>2KN: 2Kz solo per versione "C" 30N: 2Kz solo per versione "C"</p>	<p>LC4H <input type="text"/> <input type="text"/> <input type="text"/> <input type="text"/> <input type="text"/> J</p> <p>-: ingresso non in tensione PS: ingresso non in tensione, fattore di scala, alim. 12VDC PSV: ingresso in tensione, fattore di scala, alim. 12VDC S: ing. non in tensione, fattore di scala SV: ing. in tensione, fattore di scala</p> <p>S: uscita relé T: uscita transistor</p> <p>4: quattro cifre 6: sei cifre</p> <p>240AC: da 100a 240Vac 24AC: 24VAC/24Vdc 24: da 12 a 24Vdc</p> <p>: terminali a 11PIN S: terminali a vite</p>	<p>LC4HW <input type="text"/> <input type="text"/> <input type="text"/> J</p> <p>R6: uscita relé 6 cifre T6: uscita transistor 6 cifre</p> <p>240AC: da 100a 240Vac 24AC: 24VAc/24Vdc 24: da 12 a 24Vdc</p> <p>: terminali a 11PIN S: terminali a vite</p>
---------------	---	---	--

Contaore

LH2H

TH13/23

TH8

TIPOLOGIA



TH13



TH23



DIMENSIONI

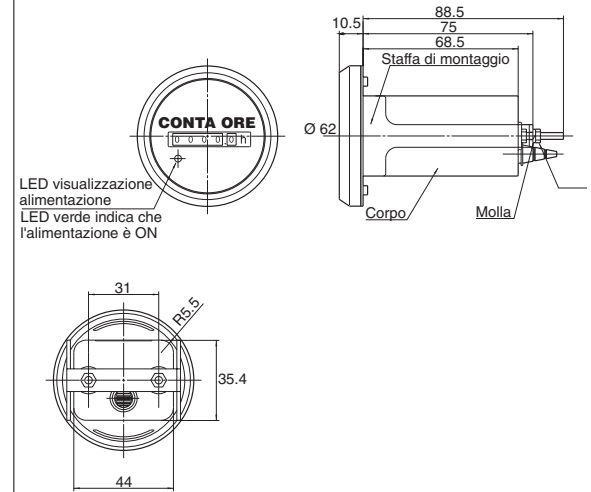
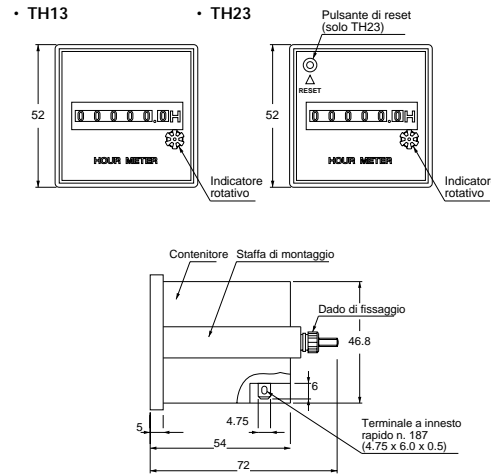
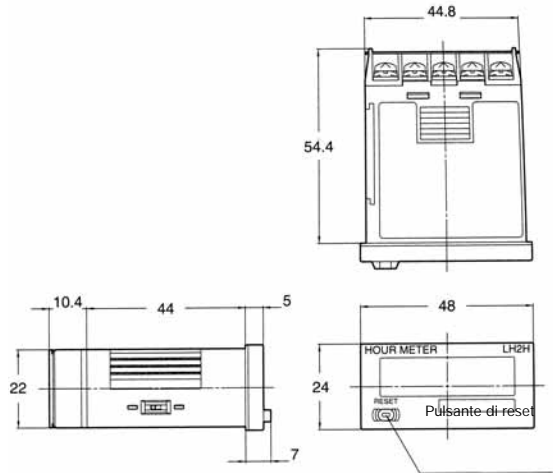

MODELLI

LH2H-F / LH2H-C

LH2H-F-DHK-DL / LH2H-F-HMK-DL

LH2H-F-DHK-FV / LH2H-F-HMK-FV

TH13/TH23

TH8

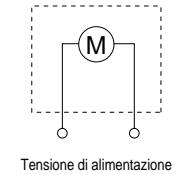
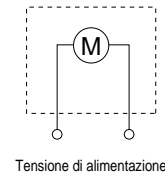
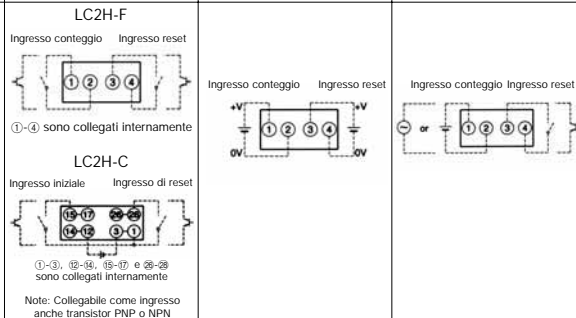

SCHEMI DI CABLAGGIO



INGRESSO	ingresso non in tensione	ingresso in tensione da 4,5 a 30VDC	ingresso in tensione da 24 a 240 VAC/DC	motore in AC		motore in DC
ALIMENTAZIONE	batteria al litio, vita ca. 6 anni			24 VAC, da 115 a 120V, 220VAC		12VDC, 24VDC
FREQUENZA NORMALE	50Hz			50Hz o 60Hz		-
DISPLAY	7 cifre LCD			analogico 5 cifre	analogico 6 cifre	analogico 5 cifre
RESET	reset frontale escludibile			senza reset	con reset	senza reset
SCALA DEI TEMPI	da 0 a 999999,9h selezionabili in gg, h, min, sec			da 0 a 99999,9h	da 0 a 9999,9h	Da 0 a 9999,9h
TEMPO MINIMO VISUALIZZATO	1s			0,1 ora (6 min)		0,1 ora (6 min)
GRADO DI PROTEZIONE	IP66 superficie pannello			IP40		IP66 superficie pannello

Tabella codici CONTAORE

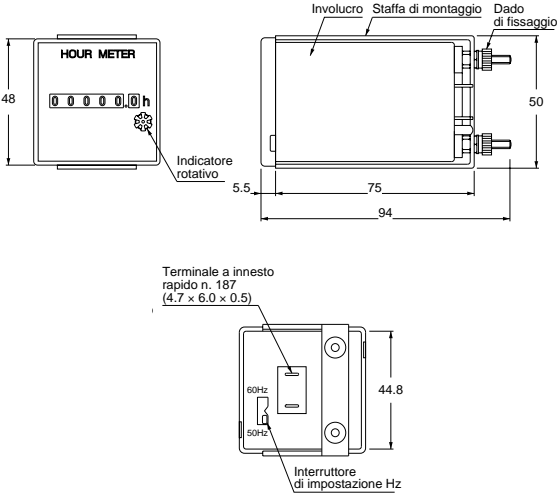
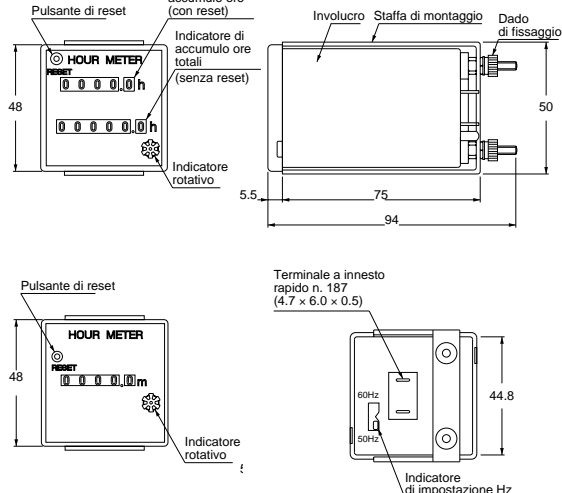
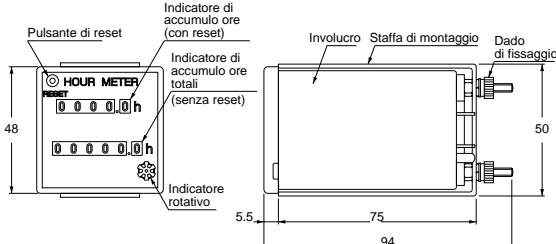
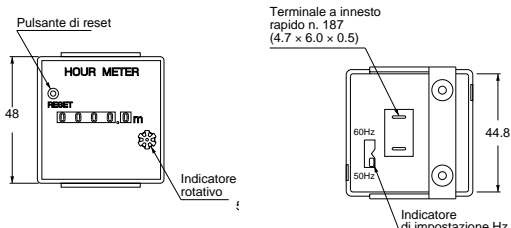
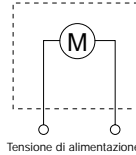
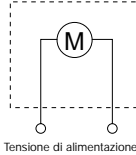

Come ordinare	<p>Tipo standard / retroilluminato:</p> <p>LH2HF <input type="text"/> J</p> <p>DHK ingresso non in tensione HMK ingresso non in tensione DHKDL ingresso in tensione HMK ingresso in tensione DHKFV ingresso multitensione HMKFV ingresso multitensione DHKDLB ingresso in tensione retroillum. HMKDLB ingresso in tensione retroillum.</p> <p>Tipo per montaggio su circuito stampato:</p> <p>LH2HC <input type="text"/> J</p> <p>HN: ore/giorni ingresso non in tensione HMN: ore/minuti ingresso non in tensione</p>	<p>TH13 <input type="text"/> CEJ</p> <p>26: 24VAC 60Hz 76: da 115 a120VAC 60Hz 86: 220VAC 60Hz 25: 24VAC 50Hz 75: da 115 a120VAC 50Hz 85: 220VAC 50Hz</p> <p>TH23 <input type="text"/> CEJ</p> <p>26: 24VAC 60Hz 76: da 115 a120VAC 60Hz 86: 220VAC 60Hz 25: 24VAC 50Hz 75: da 115 a120VAC 50Hz 85: 220VAC 50Hz</p>	<p>TH83 <input type="text"/> J</p> <p>3C: 12Vdc 4C: 24Vdc</p>

Contaore	TH14/24	TH40/TH50	TH63/TH64
TIPOLOGIA	 <p style="text-align: center;">TH14 TH24</p>	 <p style="text-align: center;">TH40 TH50</p>	 <p style="text-align: center;">TH63 TH64</p>
DIMENSIONI	 <p>Technical drawings of TH14/TH24 showing front, side, and terminal views with dimensions. Dimensions include 48, 50, 5.5, 75, 94, and 44.8. Labels include: Involucro, Staffa di montaggio, Dado di fissaggio, Indicatore rotativo, Pulsante di reset, Indicatore di accumulo ore (con reset), Indicatore di accumulo ore totali (senza reset), Terminale a innesto rapido n. 187 (4.7 x 6.0 x 0.5), Interruttore di impostazione Hz.</p>	 <p>Technical drawings of TH40/TH50 showing front, side, and terminal views with dimensions. Dimensions include 48, 50, 5.5, 75, 94, and 44.8. Labels include: Pulsante di reset, Indicatore di accumulo ore (con reset), Indicatore di accumulo ore totali (senza reset), Involucro, Staffa di montaggio, Dado di fissaggio, Indicatore rotativo, Terminale a innesto rapido n. 187 (4.7 x 6.0 x 0.5), Pulsante di reset, Indicatore di impostazione Hz.</p>	 <p>Technical drawings of TH63/TH64 showing front and side views with dimensions. Dimensions include 24, 48, 4.5, 53, 66, and 44.8. Labels include: Pulsante di reset (solo per il tipo TH64), Indicatore rotativo, Selettore Hz, Terminale a innesto rapido n.187.</p>
MODELLI	TH14/TH24	TH40/TH50	TH63/TH64
SCHEMI DI CABLAGGIO	 <p>Tensione di alimentazione</p>	 <p>Tensione di alimentazione</p>	 <p>Tensione di alimentazione</p>

INGRESSO	motore in AC		motore in AC		motore in AC	
ALIMENTAZIONE	12 VAC; 24 VAC; 48 VAC; da 115 a 120 VAC; 220 VAC		12 VAC; 24 VAC; 48 VAC; da 115 a 120 VAC; 220 VAC		12 VAC; 24 VAC; 48 VAC; da 115 a 120 VAC; 220 VAC	
FREQUENZA NORMALE	50Hz o 60Hz		50Hz o 60Hz		50Hz o 60Hz	
DISPLAY	analogico 5 cifre	analogico 6 cifre	analogico con doppio conteggio parziale 5 cifre, totalizzatore 6 cifre		analogico 6 cifre	analogico 5 cifre
RESET	senza reset	con reset	con reset		senza reset	con reset
SCALA DEI TEMPI	da 0 a 99999,9h	da 0 a 9999,9h	totalizzatore da 0 a 99999,9h parziale da 0 a 9999,9h		da 0 A 99999,9h	da 0 A 99999,9h
TEMPO MINIMO VISUALIZZATO	0,1 ora (6 min)		0,1 ora (6 min)		0,1 ora (6 min)	
GRADO DI PROTEZIONE	IP40		IP40		IP40	



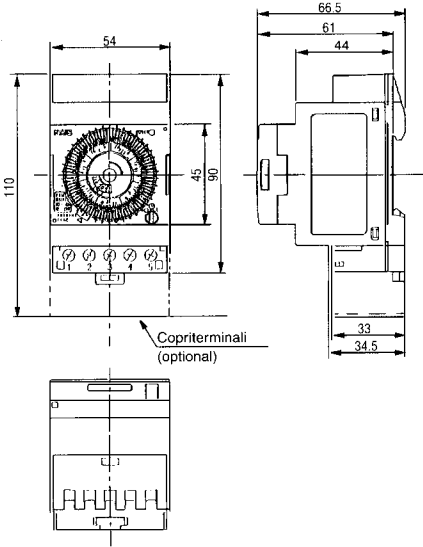
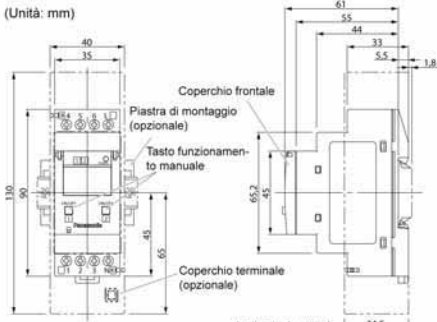
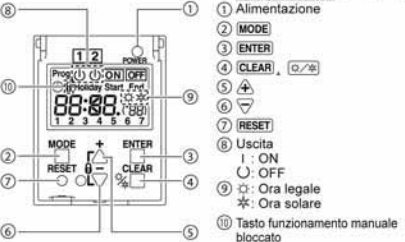
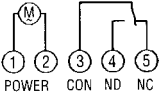
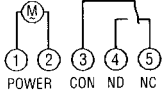
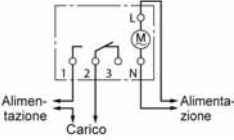
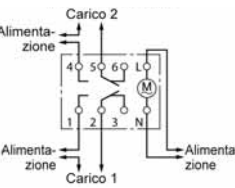

Tabella codici CONTAORE

Come ordinare	<p style="text-align: right;">TH14 <input type="text"/> J</p> <p>3: 12VAC 4: 24VAC 5: 48VAC 7: da 115 a120VAC 8: 220VAC</p>	<p style="text-align: right;">TH40 <input type="text"/> J</p> <p>3: 12VAC 4: 24VAC 5: 48VAC 7: da 115 a120VAC 8: 220VAC</p>	<p style="text-align: right;">TH63 <input type="text"/> CEJ</p> <p>3: 12VAC 4: 24VAC 5: 48VAC 7: da 115 a120VAC 8: 220VAC</p>
	<p style="text-align: right;">TH24 <input type="text"/> J</p> <p>3: 12VAC 4: 24VAC 5: 48VAC 7: da 115 a120VAC 8: 220VAC</p>	<p style="text-align: right;">TH50 <input type="text"/> J</p> <p>3: 12VAC 4: 24VAC 5: 48VAC 7: da 115 a120VAC 8: 220VAC</p>	<p style="text-align: right;">TH64 <input type="text"/> CEJ</p> <p>3: 12VAC 4: 24VAC 5: 48VAC 7: da 115 a120VAC 8: 220VAC</p>

Programmatori orari	TB5		TB6	
TIPOLOGIA				
DIMENSIONI			<p>(Unità: mm)</p>  <p>Indicazioni e tasti:</p> <ul style="list-style-type: none"> ① Alimentazione ② MODE ③ ENTER ④ CLEAR ⑤ ▲ ⑥ ▼ ⑦ RESET ⑧ Uscita ⑨ ON ⑩ OFF ⑪ Ora legale ⑫ Ora solare ⑬ Tasto funzionamento manuale bloccato 	
MODELLI	TB5560187NJ	TB5630187NJ	TB6210187NJ	TB6220187NJ
SCHEMI DI CABLAGGIO			<p>Circuito a 1 canale</p> 	<p>Circuito a 2 canali</p> 

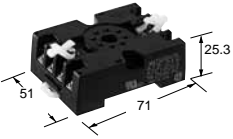
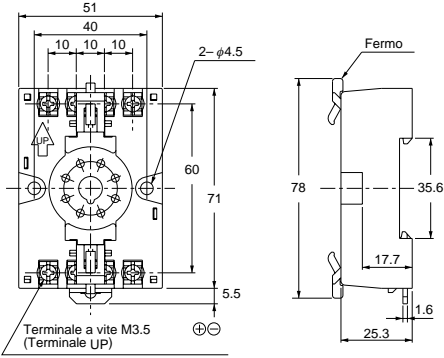
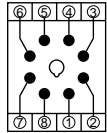
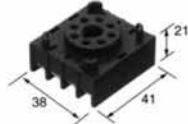
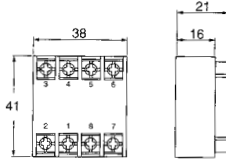
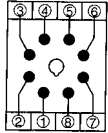
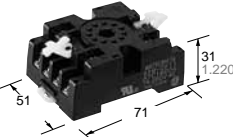
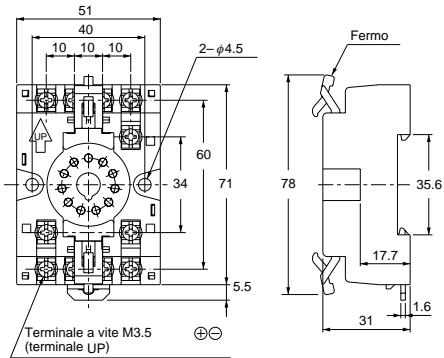
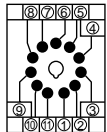
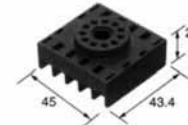
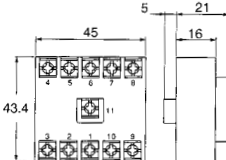
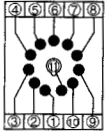
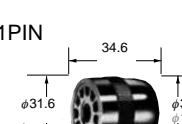
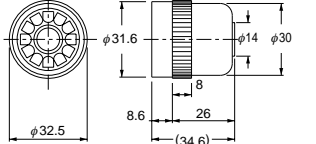
FUNZIONAMENTO	motore al quarzo giornaliero o settimanale motore sincrono giornaliero o settimanale	Elettronico settimanale	
ALIMENTAZIONE	motore al quarzo 220 - 240 VAC motore sincrono 230 VAC	220 - 240 VAC	
FREQUENZA NOMINALE	1 canale	1 canale	2 canali
DISPLAY	1 contatto in scambio	1 in scambio	2 in scambio
RESET	16A 250 VAC	16A a 250 VAC	
SCALA DEI TEMPI	15 minuti giornaliero; 2 ore settimanale	1 minuto	
TEMPO MINIMO VISUALIZZATO	96 giornaliero; 84 settimanale	50 programmi/circuito	50 programmi
GRADO DI PROTEZIONE	IP20	IP20	

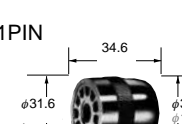
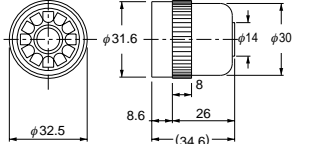
ZOCCOLI (Unità: mm=, Tolleranza: ±1)

Tipo	Zoccoli per barra DIN	Dimensioni	Collegamento terminali (visione dall'alto)	Zoccoli volanti	Dimensioni	Collegamento terminali (visione dall'alto)
<p>PM4H-S PM4H-M PM4H-SD PM4H-F8 PM4H-F8R PM4H-W LT4H LT4H-W (versione a 8-pin) LC4H (versione a 8-pin)</p>	<p>(8-pin)</p>  <p>ATC180031</p>			 <p>AT78041</p>		
<p>PM4H-A PM4H-F11R LT4H LT4H-W (versione a 11-pin) LC4H LC4H-W (versione a 11-pin)</p>	<p>(11-pin)</p>  <p>ATC180041</p>			 <p>AT78051</p>		
				<p>• 8PIN</p>  <p>AD8-RC</p>		
				<p>• 11PIN</p>  <p>AT8-DP11</p>		

Nota: il numero dei terminali sul temporizzatore e sul contaimpulsì corrisponde a quelli sullo zoccolo.

Componenti ed accessori per TEMPORIZZATORI E CONTAIMPULSI

COMPONENTI PER L'INSTALLAZIONE

• Guarnizione in gomma

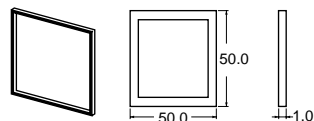

ATC18002

Per serie PM4H,
LT4H e LC4H

La guarnizione in gomma è in dotazione nella serie PM4H (versione con terminale a vite), LT4H, LC4H.

Dimensioni



AT8-DA4

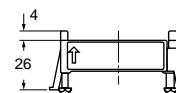
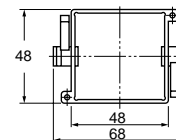

Per serie PM4H,
LT4H e LC4H.

La guarnizione in gomma è in dotazione nella serie PM4H (versione con terminale a vite), LT4H, LC4H.

ACCESSORI

• Pannellino (Nero)

LC4H pannellino (4 cifre)
LT4H pannellino (4 cifre)



AEL58011

LC4H pannellino (6 cifre)



AEL58012

LT4H-W pannellino
LC4H-W pannellino



AEL68011

LC4H-S pannellino (4 cifre)



AEL58013

LC4H-S pannellino (6 cifre)



AEL58014

PM4H-A



ATC18011

PM4H-S



ATC18012

PM4H-M



ATC18013

PM4H-W

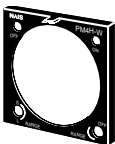

ATC18014

PM4H-SD



ATC18015

PM4H-F

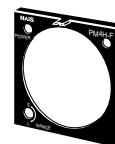

ATC18016

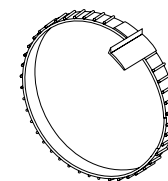

ATC18001

Ghiera di fissaggio
per la manopola
di impostazione
del tempo.

